

# Kährs

## Traditional Tongue & Groove Float-In Installation 14mm, 15mm, 20mm

---

### Table of Contents

#### **Jobsite**

Subfloor Preparation . . . . .	2 - 5
Underlayments . . . . .	6

#### **Layout**

Calculation Worksheet for Min. Board Width (U.S. Std.) . . . . .	7
Calculation Worksheet for Min. Board Width (Metric) . . . . .	8
Required Expansion Reference Chart (Metric) . . . . .	9
Required Expansion Reference Chart (U.S. Std.) . . . . .	10

#### **Tools & Techniques**

Important Installation Notes . . . . .	11
Kährs Product Key . . . . .	12-13
Traditional Tongue & Groove Float_In Installation 14mm, 15mm, 20mm . . . . .	14-17
<b>Note: for Radiant Heat applications, see Radiant Heat Special Instructions at <a href="http://www.kahrs.com">www.kahrs.com</a></b>	

#### **Follow Up**

Recoating Your Floor . . . . .	18
--------------------------------	----

### Approved Commercial Uses

Kährs flooring may be used as a floor covering in public or private business, educational or religious buildings and offices.

Installation in any and all areas where food or drinks are consumed, or areas contiguous to outside entrances must be coated with a compatible wood finish urethane, in accordance with the finish manufacturers application procedures. Kährs recommends Bona Kemi or Bona Traffic in these cases. Contact Bona Kemi for details ([www.bona.com](http://www.bona.com)).

Kährs does not warranty the performance of any site-applied finish. Please contact the finish manufacturer for suitable products, procedures, and warranty.

#### **Maintenance**

See Kährs Commercial Flooring Maintenance Procedures (Kährs Commercial Warranty) for maintenance details (available at [www.kahrs.com](http://www.kahrs.com)).

For prefinished oiled floors, please refer to Natural Oiled Floors Maintenance and Renovation Procedures at [www.kahrs.com](http://www.kahrs.com)

## Subfloor Preparation

**Note:** *Warranty coverage may be lost due to failure to strictly follow all installation instructions and recommendations and/or the use of improper materials or tools.*  
**READ ALL INSTRUCTIONS CAREFULLY!**

### Subfloor Specifications

- A. The surface of the subfloor must be level to within 1/8" in an 8ft. radius. Check this by using the edge of a Kährs or Linnea plank to find high/low spots. To fill excessive voids or variations in the subfloor, use leveling compounds approved for your application. Consult the compound manufacturer to be sure it is appropriate. Allow the compound to dry thoroughly before beginning wood floor installation. Fifteen-pound felt or roofing paper is also appropriate to level a floor for a float-in installation. Cut small pieces to fit the shape of the depression and then stack as many sheets as necessary to level the area. DO NOT use this method to correct extensive variations in concrete subfloors.
- B. **You must** test concrete subfloors prior to installation by one of the following methods. Concrete subfloors must not contain more than 3 lbs. moisture on a dry-weight basis (calcium chloride test). Subfloor must read 4.5 or less with Tramex meter. Follow ASTM2170 - subfloor relative humidity not to exceed 75% with in-situ probe. Moisture content of wood subfloors must be less than 12% Moisture Content (MC). Document and keep ALL test results. Subsequent excessive moisture after pre-installation documented testing is evidence of moisture intrusion and will not be covered under Kährs warranty.
- C. The subfloor must be clean.
- D. Relative humidity at the job site must be, and remain, minimum 30%, maximum 60%. Temperature setting must be, and remain, within 15° F of normal operating range.

### Evaluation

Before installing a Kährs floor, inspect the job site thoroughly. With the help of the Installation Environment Chart determine if grade, subfloor, and subfloor conditions are acceptable for the installation method you plan to use.

Exterior: Carefully inspect the outside surroundings for improper drainage and predictable or obvious sources of moisture. The yard should be graded (at least 6" in 10 ft.) to slope away from the foundation. Be sure that gutters and eaves sufficiently prevent rain from penetrating the foundation.

Under the house: In homes with crawl space or pier-beam foundations, foundation vents must provide cross-ventilation with no dead air space. Vents should be located throughout the foundation with opening area equal to 1-1/2% of the square-foot area within the crawl space (eg. a 1000sq. ft. crawl space must have 15 sq. ft. of vents that remain open all year). If excessive moisture exists underneath the house, you must lay a 6 mil black polyethylene moisture barrier on the ground in the crawl space below the installation area.

Interior: Check the moisture content of the subfloor. See item "B" above as well as "Moisture" at the end of this section. Room conditions can also indicate high moisture and relative humidity. Look for water stains, peeled paint near windows and doors, and rusty metal, especially nails.

### Preparation

Wood Subfloors: Moisture Content (MC) must be less than 12%. To prepare the subfloor for installation, reoil any loose areas with squeaks. Sand or plane any high spots and fill any low areas. The subfloor should not vary more than 1/8" in an 8' radius. Check this by using the edge of a Kährs or Linnea plank to find any high or low spots. See Installation Environmental Chart for Approved Subfloors.

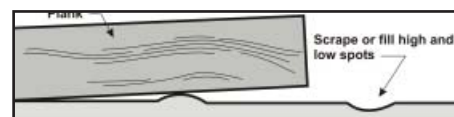

## Subfloor Preparation

### Preparation (con't.)

**Preferred Subflooring:** 3/4" (23/32", 18.3 mm) CDX grade plywood subfloor/underlayment (Exposure 1) 4' x 8' sheets OR 3/4" (23/32" 18.3mm) OSB subfloor/underlayment grade, with joint spacing 19.2" (475mm) on center joint construction or less. Direct Glue-Down installations: 2 layers 1/2" (11.9mm) CDX plywood.

**Minimum Subflooring:** 5/8" (19/32", 15.2mm) CDX plywood subfloor/underlayment (Exposure 1) 4' x 8' sheets, maximum 16" (400mm) on center joint construction. Direct Glue-Down installations: 2 layers 3/8" (10mm) CDX plywood.

Follow panel manufacturer recommendations for spacing and fastening. Typical panel spacing for joint systems is 1/8" (3.2mm) around perimeter and fastened every 6" (150mm) on bearing edges and every 12" (300mm) along intermediate supports.

Door casings should be notched or undercut to avoid difficult scribe cuts.

If nailing the floor, (Kährs 14, 15, 20mm Traditional Tongue & Groove only) we suggest you cover the sub floor with 15 lbs. or higher asphalt felt or rosin paper to retard moisture and to help alleviate variations in the subfloor.

**Concrete Subfloors:** Lightweight (float-in only) and standard-density (float-in and glue-down) concrete subfloors are ideal applications for a Kährs floor. Concrete subfloors are generally acceptable for float-in installation if the subfloor appears to be dry (i.e. no standing water or discoloration of concrete) and Kährs Combo System Underlayment is used and installed properly. Be sure that, as a minimum, any concrete subfloor is at least 50-60 days old before installing a wood floor over it.

### Moisture

To curb the adverse effects moisture will have on a Kährs wood floor and to determine the source of moisture problems, use the following checklist:

1. Inspect the gutters, drains, and down spouts outside the house. Clear out any clogs caused by leaves, dirt, or other substances. Down spouts are designed to transport water away from a foundation.
2. Check the landscaping surrounding the home to be sure the yard is sloped away from the foundation (at least 6" in 10 ft.).
3. Check windows and doors for proper drainage and waterproof caulking.
4. Inspect concrete subfloor for cracks or buckling. Sometimes the water table (water beneath the surface) may rise and force water up through the concrete floor with hydrostatic pressure.
5. Check the ventilation system in the crawl space, basement, and attic. Moisture will collect on walls and floors if dead air (i.e. little or no ventilation) is present. As a rule, ventilation per sq. ft. should equal 1-1/2% of the sq. ft. of the area in question.
6. Inspect pipes, water heater tank, dishwasher, and any other plumbing fixtures in the affected area.
7. Remember to take seasonal changes in relative humidity into consideration when installing a Kährs floor.
8. Signs that the moisture content is too high include discolored (darker) concrete and evidence of actual water droplets.

## Subfloor Preparation

### Moisture (con't.)

**Required moisture testing for ALL Kährs radiant heat installations and direct glue-down flooring:**

Calcium Chloride test with a reading of 3 lbs. or less on a dry weight basis (2 lbs. or less for Radiant Heat Installations). Testing kits are generally available through your distributor or call the NFWA at 800-422-4556 (or 800-848-8824 in Canada) for the source nearest you. Follow test kit manufacturer's instructions for conducting test and measuring results. If calcium chloride results read over 3 lbs. but does not exceed 8 lbs. (and no obvious source of the moisture can be eliminated) you must use either of the following approved moisture sealers before installing the floor for the **Kährs Moisture Protection Warranty to apply:**

**Warranty to apply:**

- DriTac MCS 7000 when used with DriTac 7600 or 7500 Adhesive (call 800-394-9310 for source nearest to you).
- Dependable Cutdown (call 800-227-3434 for the source nearest you).
- Concrete Moisture Barrier System\*

\* If moisture is present an alternative is a barrier of inexpensive sheet vinyl or "slip sheet" (PVC). Use the manufacturers recommended adhesive for a full spread application to completely adhere the vinyl to the subfloor. Since Kährs cannot guarantee the bond of the vinyl to the subfloor, or subsequent performance of the vinyl, a patch test is strongly advised. Install several 3" x 3" pieces of vinyl in different areas of the installation. Wait 72 hours. Remove the vinyl. If the backing remains attached to the concrete, the subfloor should be acceptable for full spread vinyl installation.

**Note:** These concrete sealers are **NOT** approved for Radiant Heat installations.

All concrete sealer/vinyl manufacturer testing, documentation, and installation requirements **MUST** be followed for Kährs Limited Warranty to apply.

**Other Subfloors:** Kährs floors can be installed directly over some existing floors (i.e. vinyl and rubber tile, steel plates, terrazzo, and existing wood floors). The subfloor or existing floor must meet the requirements listed in "Subfloor Specifications." A Kährs floor installed over existing floors must be installed with the float-in method.

Installation Environment Chart			
I. Grade Type	Glue**	Nail*	Float
A. Above Grade	yes	yes	yes
B. On Grade	yes	yes	yes
C. Below Grade	no	no	yes
D. Over Radiant Subfloor	no	no	yes
II. Subfloor Type	Glue**	Nail*	Float
A. Concrete (701 lbs. cu. ft. density or higher)	yes	no	yes
B. Light-weight concrete	no	no	yes
C. Association-grade underlayment plywood	yes	yes	yes
D. Association-grade underlayment particle board	yes	no	yes
E. Stamped Underlayment Grade OSB (Oriented Strand Board)	yes	yes	yes
F. Old wood floors - above grade only	no	no	yes
(next page)			

## Subfloor Preparation

Installation Environment Chart			
II. Subfloor Type (con't.)	Glue	Nail*	Float
G. Asphalt tile	no	no	yes
H. Inlaid linoleum	***	no	yes
I. Vinyl asbestos tile	no	no	yes
J. Cushion vinyl	no	no	yes
K. Rubber tile	no	no	yes
L. Solid vinyl tile	no	no	yes
M. Steel	no	no	yes
N. Marble	no	no	yes
O. Ceramic	no	no	yes
P. Carpet	no	no	no
*14mm, 15mm, 20mm T & G only			

\*\*\* Check Kährs Technical Services Department: 1-800-ASK-KAHR

## Underlayments

- Kährs Combo-System Underlayment
- Kährs QuietStride

### Combo Foam Underlayment System with Overlap:

The width of a row of Kährs Combo-System Underlayment is comprised of 40" of underlayment plus an 8" overlap flap. The overlap flap guards the flooring from moisture at the seams, where the rows of underlayment are laid side by side. The overlap flap has a peel and stick strip to aid the installation process.

1. Layout 1st row of underlayment (logo side down, blue side up) with the overlap flap facing the starting wall. Allow the underlayment to wrap up the wall, on the ends, approx. 2".
2. Reach under and grab the overlap flap and pull it up so it lies against the starting wall. Trim this overlap flap back to leave approx. 2" of plastic up the wall. (Use this cut off section to repair damage in the underlayment as needed\*, see note below).
3. Lay 2nd row of underlayment flush to first. Make sure the overlap flap is next to 1st row, and the ends wrap up the walls. (If flooring installation has already begun, make sure to stop the flooring approx. 8 inches from the side of the underlayment to allow for the installation of the overlap flap.)
4. Again, reach under and grab the overlap flap. Pull the flap up and fold it back to expose the peel and stick strip. Remove the white protective cover from the adhesive strip. Lay overlap flap across the 1st row of underlayment and press into place.
5. Continue this procedure row by row until the entire floor area is covered.

\* **Note:** When connecting a new roll of underlayment to the end of the roll you are working on, or for repairing any tears or cuts in the underlayment; overlay the butt joints or the damaged area with a spare piece of overlap plastic. This spare piece should overlay by approx. 8". Hold the spare piece in place with tape. Do NOT overlap underlayment. Overlap flap only.

Cover the entire floor area and run the underlayment up the perimeter walls approximately 2". This provides a secure enclosure for the flooring. After the floor is installed and before the installation of the baseboards, the excess underlayment should be trimmed to the height of the floor surface using a fine trimming blade. The use of the Combo-System Underlayment is also approved for Radiant Heat applications.

### Kährs QuietStride:

Quiet Stride can be installed three different ways as a Kährs underlayment.

1. *Float-in Installations:* First install 6 mil polyethylene plastic loose-laid, seams overlapped 8". Run plastic up the wall 2" (trim excess after installation, before installing trim). Loose-lay QuietStride on top of plastic, wall to wall, and butt all seams together (taping seams preferred). Use of QuietStride with polyethylene plastic is approved for float-in Radiant Heat applications.
2. *Direct Glue-Down:* Install QuietStride wall to wall, butt all seams together (do not tape seams), directly adhering to subfloor with QuietStride Adhesive\* or a premium multi-purpose adhesive. Fully adhere Kährs flooring to underlayment using approved adhesive and trowel (see *Glue-Down Installation* for details). **Note:** an approved concrete sealer must be used if calcium chloride test exceeds 3lbs. for Kährs Moisture Protection Warranty to apply.
3. *Direct Glue-Down over "float-in" underlayment:* First install 6 mil polyethylene plastic loose-laid, seams overlapped 8". Run plastic up wall 2" (trim excess after installation, before installing trim). Loose-lay QuietStride on top of plastic, wall to wall, butt all seams together (do not tape seams). Fully adhere Kährs flooring to underlayment using approved adhesive and trowel (see *Glue-Down Installation* for details). **Note:** an approved concrete sealer must be used if calcium chloride test exceeds 3lbs. for Kährs Moisture Protection Warranty to apply.

\* **QuietStride Adhesive** has been developed for adhering QuietStride Underlayment directly to the subfloor for use in "double-stick" installations. The adhesive is a quick, inexpensive technique for affixing QuietStride Underlayment to the subfloor, then gluing the Kährs flooring to the QuietStride Underlayment with one of the approved Kährs wood flooring adhesives.

- QuietStride Adhesive product ID #710248
- Sold in 1gallon pails

### Important:

**Kährs does not guarantee the performance of any non-Kährs branded underlayment.**

## Calculation Worksheet for Min. Board Width - (U.S. Std.)

**Purpose:** To ensure last board of the installation (or long board at an obstruction) is not too narrow.  
**General Rule:** Kährs requires that no board have a width less than 3" or .38" of a full board width.  
**Notes on Equation:** This rule applies to boards with an original thickness of 5/8" x 3-strip wide. This equation should be used when a board 4' or more in length meets an obstruction.

**WORKSHEET**

**Step 1**  
**Measure width of connected area\* from starting wall to finish wall or obstruction, in inches. Round to the nearest 1/4".**

Connected Area Width in inches with fraction: \_\_\_\_\_

**Step 2**  
**Convert "inches with Fraction" to "Inches with Decimal". Use conversion chart below.**

Connected Area Width in inches with decimal: \_\_\_\_\_

**Step 3**  
**Multiply "Required Expansion Space" by 2. Use chart below.**  
 Total Expansion Needed from above: \_\_\_\_\_

Connected Area Width (from Step 2)	Expansion Space	Total
Under 144"	1/4" x 2 =	.50"
144" - 288"	1/2" x 2 =	1.0"
288" - 480"	3/4" x 2 =	1.5"

**Step 4**  
**Subtract Total Expansion Needed from Connected Area Width to determine Actual Floor Width.**

Total from Step 2: \_\_\_\_\_"  
 Total from Step 3: - \_\_\_\_\_"  
 Actual Floor Width in inches with decimal: = \_\_\_\_\_"

**Step 5**  
**Determine total # of rows of flooring needed.**

Actual Floor Width (Step 4): \_\_\_\_\_"  
 Board Width in Decimal - measure board and use chart below to convert: ÷ \_\_\_\_\_"  
 Total Rows of Flooring: = \_\_\_\_\_ rows

**Step 6**  
**If the result in Step 6 contains a decimal less than .38", you must rip the starting row in half to ensure proper width of the last row.**

**EXAMPLE**

**Step 1**  
**Measure width of connected area\* from starting wall to finish wall or obstruction, in inches. Round to the nearest 1/4".**

Connected Area Width in inches with fraction: \_\_\_\_\_ 325-1/4"

**Step 2**  
**Convert "inches with Fraction" to "Inches with Decimal". Use conversion chart below.**

Connected Area Width in inches with decimal: \_\_\_\_\_ 325.25"

**Step 3**  
**Multiply Required Expansion Space by 2. Use chart below.**  
 Total Expansion Needed from above: \_\_\_\_\_ 1.5"

Connected Area Width (from Step 2)	Expansion Space	Total
Under 144"	1/4" x 2 =	.50"
144" - 288"	1/2" x 2 =	1.0"
288" - 480"	3/4" x 2 =	1.5"

**Step 4**  
**Subtract Total Expansion Needed from Connected Area Width to determine Actual Floor Width.**

Total from Step 2: \_\_\_\_\_ 325.25"  
 Total from Step 3: - \_\_\_\_\_ 1.50"  
 Actual Floor Width in inches with decimal: = \_\_\_\_\_ 323.75"

**Step 5**  
**Determine total # of rows of flooring needed.**

Actual Floor Width (Step 4): \_\_\_\_\_ 323.75"  
 Board Width in Decimal - measure board and use chart below to convert: ÷ 7.875"  
 Total Rows of Flooring: = \_\_\_\_\_ 41.11 rows\*

\* The first board in this installation would be cut in half.

**Step 6**  
**If the result in Step 6 contains a decimal less than .38", you must rip the starting row in half to ensure proper width of the last row. Ripping the starting row in half will increase the last board width by .50 of a board. In this case the last board will end up being .61 of a board or approx. 5", instead of .11 or 1" wide.**

\*From Step 1 - Connected Area is defined as all areas connected without a break. If Room A and Room B both are to have flooring installed and are directly connected, or connected by a hallway, without a t-molding, the **connected area** is the width of both Room A and Room B, and the hallway (if applicable). Obstructions can include cabinets, islands, and the wall opposite the starting wall in the same room, if the flooring continues to another room without a break. Multiple calculations may need to be made to best determine the amount cut from the starting row.

Fraction	Decimal Equivalent
1/4"	.25"
1/2"	.50"
3/4"	.75"

Board Width	Decimal Equivalent
7-7/8"	7.875"
8-1/10"	8.100"





## Calculation Worksheet for Minimum Board Width - (Metric)

**Purpose:** To ensure last board of the installation (or long board at an obstruction) is not too narrow.  
**General Rule:** Kährs requires that no board have a width less than 76mm or .38" of a full board width.  
**Notes on Equation:** This rule applies to boards with an original thickness of 15mm x 3-strip wide. This equation should be used when a board 120cm or more in length meets an obstruction.

<b>WORKSHEET</b>	
<b>Step 1</b> Measure width of connected area* from starting wall to finish wall or obstruction, in inches. Round to the nearest 1/4".	
Total Area Width in mm:	_____
<b>Step 2</b> Multiply Required Expansion Space by 2. Use chart below.	
Required Expansion Space:	_____mm
	X 2
Total Expansion =	_____mm
<b>Step 3</b> Subtract Total Expansion from Total Area Width to determine Actual Floor Width.	
Total from Step 1:	_____mm
Total from Step 2:	- _____mm
Actual Floor Width:	= _____mm
<b>Step 4</b> Determine total # of rows of flooring needed.	
Actual Floor Width (Step 3):	_____mm
Board Width. Measure board. It will be either 200 or 205mm.	÷ _____mm
Total Rows of Flooring:	= _____rows
<b>Step 5</b> If the result in Step 6 contains a decimal less than .38", you must rip the starting row in half to ensure proper width of the last row.	

<b>EXAMPLE</b>	
<b>Step 1</b> Measure width of connected area* from starting wall to finish wall or obstruction, in inches. Round to the nearest 1/4".	
Total Area Width in mm:	8262mm
<b>Step 2</b> Multiply Required Expansion Space by 2. Use chart below.	
Required Expansion Space:	20mm
	X 2
Total Expansion =	40mm
<b>Step 3</b> Subtract Total Expansion from Total Area Width to determine Actual Floor Width.	
Total from Step 1:	8262mm
Total from Step 2:	- 40mm
Actual Floor Width:	= 8222mm
<b>Step 4</b> Determine total # of rows of flooring needed.	
Actual Floor Width (Step 3):	8222mm
Board Width. Measure board. It will be either 200 or 205mm.	÷ 200mm
Total Rows of Flooring:	= 41.11 rows*
<i>*The first board in this installation would be ripped in half.</i>	
<b>Step 5</b> If the result in Step 6 contains a decimal less than .38", you must rip the starting row in half to ensure proper width of the last row. Ripping the starting row in half will increase the last board width by .50 of a board. In this case the last board will end up being .61 of a board or approx. 120mm, instead of .11 or 22mm wide.	

\* From Step 1 - **Connected Area** is defined as all areas connected without a break. If Room **A** and Room **B** both are to have flooring installed and are directly connected, or connected by a hallway, without a t-molding, the **connected area** is the width of both Room **A** and Room **B**, and the hallway (if applicable). Obstructions can include cabinets, islands, and the wall opposite the starting wall in the same room, if the flooring continues to another room without a break. Multiple calculations may need to be made to best determine the amount cut from the starting row.

Required Expansion Space Chart	
<b>Floor Width</b>	<b>Space Needed</b>
up to 750mm	12mm
750mm-1200mm	20mm



## Required Expansion Reference Chart - (Metric)

**Purpose:** To ensure proper expansion space around all walls, doors and obstructions for 14mm, 15mm, and 20mm flooring.

### Required Expansion

- Rules:**
- (1) Kährs requires 1.5mm of expansion space for every 1m of Connected Area width or 2.5m of Connected Area length (whichever is greater). This expansion space must be left around all walls, doors and obstructions. Minimum expansion requirement is 12mm.
  - (2) No connected flooring can span greater than 12m in width or 36m in length. For 20mm only, 10m width x 15m length,

- Notes:**
- (1) **Connected area** is defined as all areas connected without a break. If Room **A** and Room **B** both are to have flooring installed and are directly connected, or connected by a hallway, without a t-molding, the **Connected Area** is the width of both Room **A** and Room **B**, and the hallway (if applicable). Obstructions can include cabinets, islands, and the wall opposite the starting wall in the same room, if the flooring continues to another room without a break. Multiple calculations may need to be made to best determine the amount cut from the starting row.
  - (2) The direction of the flooring must be determined prior to calculating the required expansion space. The Connected Area width is parallel to the board width. The Connected Area length is parallel to the board length.

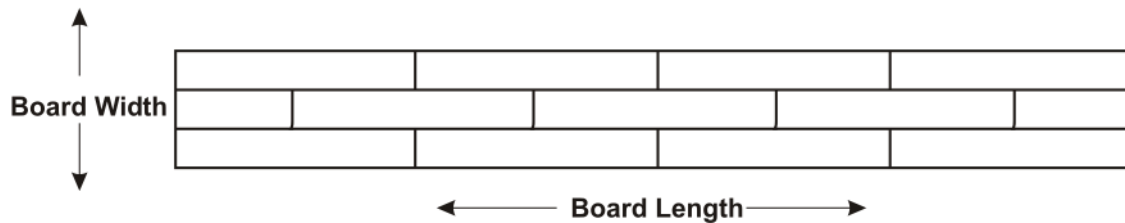

Required Expansion Reference Chart			
Connected Area Width	Required Expansion Space*	Connected Area Length	Required Expansion Space*
up to 750cm 750cm-1200cm	12mm 20mm	up to 2250cm 2250cm-3600cm	12mm 20mm

\* Determine the required expansion space for both width and length, then use the larger of the 2 on all sides, and around all obstructions.

## Required Expansion Reference Chart - (U.S. Standard)

**Purpose:** To ensure proper expansion space around all walls, doors and obstructions.

**Required Expansion**

- Rules:**
- (1) Kährs requires 1/16" of expansion space for every 3' of Connected Area width or 9' of Connected Area length (whichever is greater). This expansion space must be left around all walls, doors and obstructions. Minimum expansion requirement is 1/2".
  - (2) No connected flooring can span greater than 40' in width or 120' in length. For 20mm, maximum connected floor size is 32' width x 50' length.

- Notes:**
- (1) **Connected area** is defined as all areas connected without a break. If Room **A** and Room **B** both are to have flooring installed and are directly connected, or connected by a hallway, without a t-molding, the **connected area** is the width of both Room **A** and Room **B**, and the hallway (if applicable). Obstructions can include cabinets, islands, and the wall opposite the starting wall in the same room, if the flooring continues to another room without a break. Multiple calculations may need to be made to best determine the amount cut from the starting row.
  - (2) The direction of the flooring must be determined prior to calculating the required expansion space. The Connected Area width is parallel to the board width. The Connected Area length is parallel to the board length.

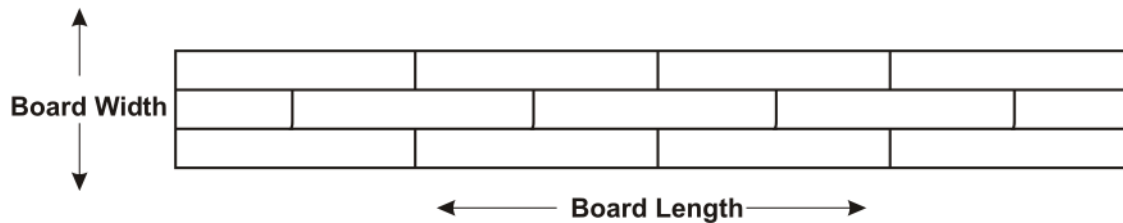

Required Expansion Reference Chart			
Connected Area Width	Required Expansion Space*	Connected Area Length	Required Expansion Space*
up to 24' 24'-40'	1/2" 3/4"	up to 72' 72'-120'	1/2" 3/4"

\* Determine the required expansion space for both width and length, then use the larger of the 2 on all sides, and around all obstructions.

## Important Installation Notes

**Please see our website - [www.kahrs.com](http://www.kahrs.com) for Kahrs Floor Care Guide and Lifetime Guarantee.**

### Installation

#### Floating:

Maximum room dimensions for a floating floor are 40ft. across the boards or 120 ft. lengthwise. Floors exceeding either of these dimensions require use of "T-Molding." **Note:** 20mm maximum connected floor size is 32'x50'.

A minimum of one butt seam is required in every row, regardless of width (e.g. hallways).

Never attach any permanent object through the flooring, affixing it to the subfloor. A float-in floor must be free to expand and contract in all directions.

#### Double Gluing (Traditional T & G Flooring Only):

Increases the strength of the bond between boards by 90% over single gluing. This is **required** for all commercial installations. **Note:** 20mm requires double gluing on all installations. All radiant heat installations require double gluing.

#### Adhesive Tape on Kahrs Floors

The use of adhesive tape on any Kährs floor for any reason (i.e. to fasten temporary protection) is not recommended and is not covered in our warranty.

Kahrs Flooring is approved for installations in ½ bathrooms only (no bathrooms including showers or bath tubs)

### Expansion in Large Areas

You may be able to attain the necessary added expansion by trimming the wallboard (i.e. sheetrock) or raising baseboards before installing floor. This will allow the floor to expand underneath the wall. For complete information please refer to Required Expansion Reference Charts on pages 8 and 9 in the Layout section of this Guide. A Kährs floor requires 1/16" expansion for every 3' across width and 1/16" expansion for every 9' along length. For example, a 28' x 28' space requires an expansion gap of 9/16" around the edge of the flooring.

### Additional Finish Coating

For additional wear protection, a waterborne urethane finish is compatible with Kährs factory finishes. The following products from Bona Kemi are recommended:

- Pacific Strong
- Traffic

Contact Bona Kemi USA, Inc. (1-800-574-4674). Follow manufacturers instructions for recoating a prefinished wood floor. Kährs International, Inc. does not guarantee the performance and/or durability of these products.

## Installation

### **Do you have the tools and products you need to install a Kahrs floor?**

Never start a job unprepared! Each installation method requires different tools and products. Use the chart below to be sure you are fully prepared to begin your installation. For your convenience, product codes (SKU's) are listed next to each Kährs product name. Where appropriate, square footage and other important information is included as well.

<b>KAHRS PRODUCT KEY (LISTED BY INSTALLATION METHOD)</b>						
<b>Product/Material</b>	<b>SKU</b>	<b>Float In</b>	<b>Radiant Heat</b>	<b>Glue Down</b>	<b>Nail Down</b>	
Kährs 20mm Flooring - Tongue & Groove	Various	Yes	Yes	Yes	Yes	
Kährs 15mm Flooring - Woodloc	Various	Yes	Yes	Yes	No	
Kährs 15mm Flooring - Tongue & Groove	Various	Yes	Yes	Yes	Yes	
Kährs 14mm Flooring - Tongue & Groove	Various	Yes	Yes	Yes	Yes	
Kährs 14mm Flooring - Woodloc	Various	Yes	Yes	Yes	No	
Kährs 11mm Flooring - Tongue & Groove	Various	No	No	Yes	Yes	
Kährs 10mm Flooring - Woodloc	Various	Yes	Yes	Yes	No	
Kährs 7mm Flooring - Woodloc	Various	Yes	Yes	Yes	No	
Combo System Underlayment (subfloor)	710730CSU	Yes	Yes	No	Tar/Roofing	
QuietStride Underlayment	710113	Yes	Yes	Yes	No	
QuietStride Adhesive	710248	No	No	Yes	No	
Prefinished Moldings	Various	Yes	Yes	Yes	Yes	
Landobond Adhesive; 239 sq.ft. per bottle	710225	Yes	Yes	Yes	Yes	
Woodloc 5S Lock/Unlock Tool	710559	Yes	Yes	Yes	Yes	
Knocking Block, T & G Float-In and Nail-Down, 14, 15mm	710202	Yes	Yes	No	Yes	
Knocking Block, T&G, Woodloc Glue-Down 14mm &15mm	710281	No	No	Yes	No	
Knocking Block, Glue Down 11mm	710290	No	No	Yes	No	
Woodloc Hand Block (Woodloc only)	710266	Yes	Yes	No	No	
Woodloc Installation Wedge (Woodloc only)	710267	Yes	Yes	No	No	
Last Board Puller (Jemmy)	710203	Yes	Yes	Yes	Yes	
Nail Plate Adapter 15mm for use with Bostitch Mach III	710268	No	No	No	Yes	
Nail Plate Adapter 14, 15mm for use with Bostitch Mach III	710269	No	No	No	Yes	
Expansion Shims	710283	Yes	Yes	Yes	Yes	
Recommended Mastic*** Taylor 2071, Dri Tac, Stauf	Various	No	No	Yes	No	

*(continued next page)*

\* Tongue & Groove only

\*\* Contact Kährs Customer Service

\*\*\* Alternative: any moisture cured urethane wood flooring adhesive. See Glue-Down sections for details.

## KAHRS PRODUCT KEY (LISTED BY INSTALLATION METHOD)

Product/Material	SKU	Float In	Radiant Heat	Glue Down	Nail Down
Spline - Kährs 11, 14, 15, 20 mm only - to change directions	**	Yes	Yes	Yes	Yes
Router Bit Kährs 11mm	710291S	Yes	Yes	Yes	Yes
Router Bit Kährs 14, 15mm	710291	Yes	Yes	Yes	Yes
Kährs Wood Cleaner	710280	Yes	Yes	Yes	Yes
Peel & Stick Floor Protectors	710287	Yes	Yes	Yes	Yes
Touch Up Kits	710273-79	Yes	Yes	Yes	Yes

## Float-In Installation for Traditional Tongue & Groove

### NOTES:

- **Kährs flooring is covered by a Limited Lifetime Warranty. However, Warranty coverage may be lost due to failure to strictly follow all installation instructions and recommendations or the use of improper materials or tools. READ ALL INSTRUCTIONS CAREFULLY.**
- **Always begin a Kährs tongue & groove installation with the grooves facing the wall!**
- **Floating installation requires use of Kährs Approved Underlayment Systems. Refer to Underlayment section of this Guide.**
- **Proper expansion must be left at all walls and all vertical obstructions (e.g. fire place, doorjambs, etc).**
- **For subfloor and environmental specifications, see Jobsite/Subfloor Preparation section.**

### IMPORTANT!

- **Do not open packages until ready to begin installation!** Inspect boards before installation. Kährs flooring is sealed at the factory with a 7% moisture content. Opening cartons to acclimate the flooring (as with some solid strip flooring) could result in a difficult installation.
- As an installer, it is your responsibility to be aware of the grade, Relative Humidity of the room, and moisture content of the subfloor. You should check that each plank is free of damage or manufacturing defects. Any unusable boards should be set aside for later replacement.

### Prior to Installation

- See Jobsite/Subfloor Preparation section and follow all requirements before installation.
- Door casings should be notched or undercut to avoid difficult scribe cuts.
- Sweep or vacuum subfloor thoroughly.
- Floating installation requires use of Kährs Approved Underlayment Systems.. Please refer to Jobsite/Underlayments, this Guide, for details.

#### Tools and Materials Required

- Tape Measure
- Chalk Line
- Last Board Puller
- Hammer
- Knocking Block
- Landobond™ Adhesive
- Expansion Shims
- Floor Protectors
- Kährs Router Bit
- Spline

For SKU numbers see Kährs Product Key in Tools & Techniques, page 12.

## Float-In Installation for Traditional Tongue & Groove

### Step 1: First Row

- 1.1 Start with groove sides of board facing starting walls. If starting wall is not square or otherwise irregular, scribe first row (Fig. 1.1), then cut boards to match variation in wall. Important: First row must be square to ensure true, fixed base from which to build entire floor.
- 1.2 Always leave appropriate expansion gap between boards and walls (Fig. 1.2). See Layout/Required Expansion Ref. Chart on pages 9-10. Use expansion shims spaced every 12" along all walls to help prevent avoidable movement during remainder of installation. Ensure at least one end joint is in each row, regardless of row width (e.g., hallways). Note: Installation of 14mm (9/16") flooring - open two or three cartons of flooring and "rack" (dry-lay) material prior to installation to ensure proper end joint stagger and usage of all four board lengths packaged in each carton.
- 1.3 Apply 1/8" bead of Landobond™ adhesive to upper inside of grooves on board (Fig. 2.2). Note: Since first row boards lie against starting wall, only apply adhesive to board ends.

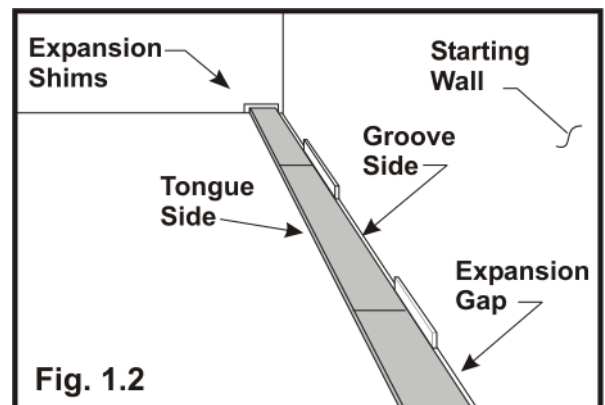
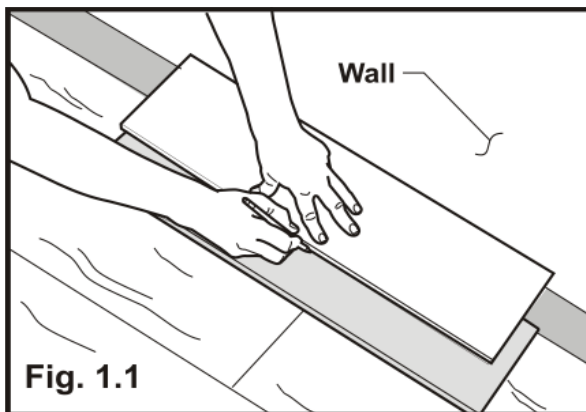

### Step 2: Subsequent Rows

- 2.1 Start each subsequent row with cut off end of last board from previous row (Fig. 2.1). Beginning at left, stagger end joints by a minimum of 20" for Kährs 15 & 20mm flooring. For Kährs 14mm flooring use **minimum 5" stagger, preferred 8"**.
- 2.2 Apply 1/8" bead of Landobond™ adhesive to inside of grooves on board (Fig. 2.2). Double glue all 20mm boards.

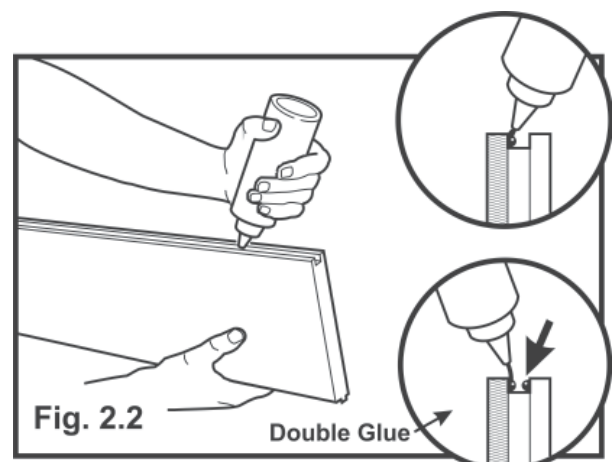
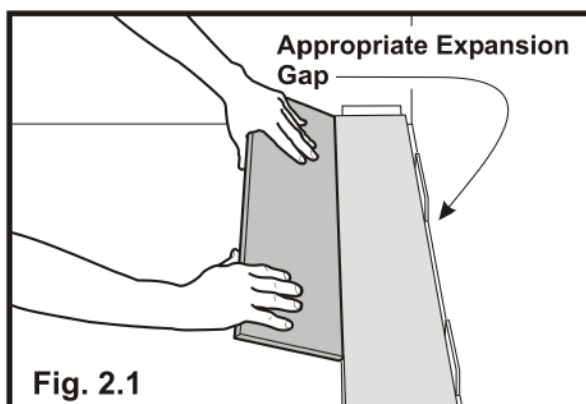



## Float-In Installation for Traditional Tongue & Groove

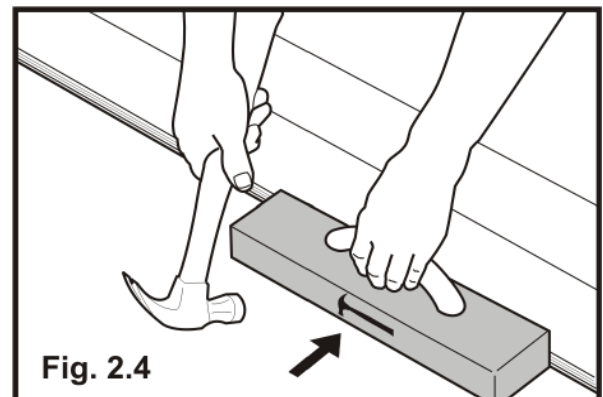
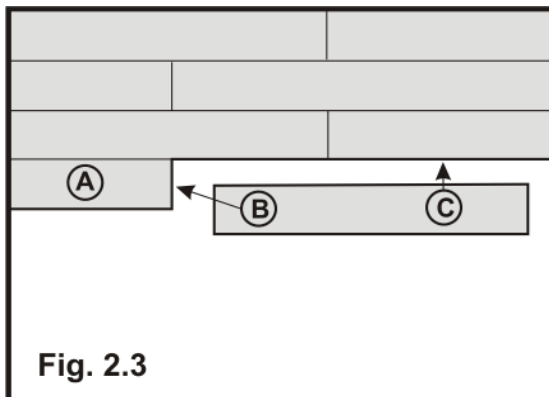

### Step 2: Subsequent Rows (con't.)

2.3 Procedure for installing each board (Fig. 2.3):

- A) Set cut-off board from previous row as described in Step 2.1. Remember to allow for expansion gap and shim accordingly.
  - B) Engage new board at end joint only.
  - C) Starting at opposite end from engaged end joint, begin knocking length of board to engage groove with tongue of adjacent board.
  - D) If needed, use Last Board Puller or Knocking Block to reset end joint before completely engaging groove with tongue of adjacent board. Once long joints are engaged, it is virtually impossible to close end joints.
  - E) If gap exists at end joint after engaging long joint, work/wiggle board away from adjacent board to slightly open seam, then tap board end to close end joint.
- 2.4 Finish setting board by placing Knocking Block against tongue side and gently tapping board flush to previous row as shown in Fig. 2.4. **Never** tap groove side or top surface layer!
- 2.5 At end of row, cut board to appropriate length (allowing for expansion gap), apply adhesive and install as described above. If necessary, use Last Board Puller to gently pressure board into place as shown in Fig. 2.5.
- 2.6 Check all seams for tight fit and move on to next row.

**Changing Directions:** If necessary to continue floor in reverse direction (e.g. through doorway), or away from groove, Kährs Spline Tongue must be used. Apply glue to groove and insert spline tongue, converting groove into tongue. **Note:** Kährs 14mm (9/16") flooring only: use Kährs Router Bit to re-cut groove, then insert spline. Board(s) to be installed adjacent must have grooves re-cut using Router Bit prior to engaging with routed/splined boards to ensure tight, level fit.

### Step 3: Last Row

Since last row will generally not fit perfectly, scribe row as shown in Fig. 1.1, remembering to allow adequate expansion gap. Engage all seams with Last Board Puller.

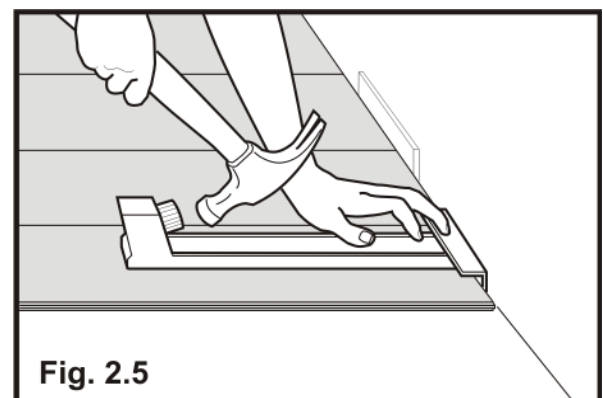

## Float-In Installation for Traditional Tongue & Groove

### After Installation

- Remove expansion shims and use required Kährs moldings and/or trim pieces to cover expansion space (Fig. A). **Always** nail moldings to wall, **never** to flooring!

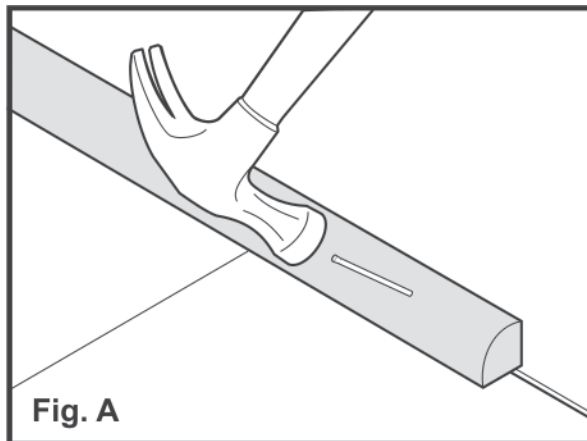

### Clean Up

- Immediately clean any Landobond™ adhesive spilled on wood flooring during installation.

### Maintenance

- Clean floor using dry dust mop or damp (lightly misted or well rung out) mop or cloth. Regularly use Kährs Wood Floor Cleaner for best results. Do not use oil soap or water-emulsion, self polishing waxes. **NEVER** wet mop floor. Place Peel & Stick Floor Protectors on furniture legs to prevent damage. See Kährs Floor Care Guide & Lifetime Guarantee for full details (available at [www.kahrs.com](http://www.kahrs.com)).

For prefinished oiled floors, please refer to Natural Oiled Floors Maintenance and Renovation Procedures at [www.kahrs.com](http://www.kahrs.com)

## Recoating your Kährs Floor

Kährs floors can be renewed without removing the factory finish. As a floor ages, normal wear and tear will cause a floor to lose its luster. This is natural - it happens to all wood floors. To renew the luster and extend the wear layer of the Kährs floor, recoat with water based urethane coating.

Recoating should be done when necessary. Don't wait until the finish has worn down. Call your professional flooring contractor for recommendations as soon as you see a wear pattern developing.

### **Preparation:**

Whether coating a floor upon installation or at a later date when it begins to show wear, the following recoating procedures are recommended:

1. Kährs recommends the BonaTech® Prep chemical bonding system for recoating all Kährs floor. Please contact Bona Kemi USA @ 1-800-574-4674 for product information, directions, and qualified professionals in your area.
2. Do not use water based urethane over a floor that has been waxed or oiled. If unsure, wipe a small section of the floor with a white rag dampened with mineral spirits to test for wax or coat a test area to check adhesion prior to coating the entire floor. It is imperative, regardless of the age of the floor, to test for adhesion.

### **Application:**

Application of a waterborne finish should be done according to instructions on the product label. Important factors to consider with any urethane are:

- Shake or Stir Bottle: There will also be a sitting time to consider before using.
- Coverage/Feet per Gallon : This will dictate how heavy or thin the finish is designed to be applied.
- Dry Time: Average time before a finish can be recoated.
- Curing Time: This includes time before a floor is walked on, time before normal use, and complete cure time.

**Note:** To achieve a uniform look, coat the worn traffic areas first, followed by a coat over the entire floor.

#### **Recommended finishes from Bona Kemi:**

- Pacific Strong
- Traffic

Call Kährs Technical Line (1-800-ASK-KAHR) for other compatible floor finishes.

**Note:** For prefinished oiled floors please refer to Natural Oiled Floors Maintenance and Renovation Procedures at [www.kahrs.com](http://www.kahrs.com)